

## 1941-48 Ford and Mercury Convertible & Wagon Windshield & Top

### Windshield to Body

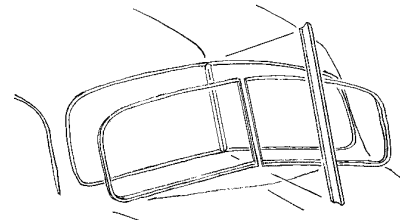

21A-761290	Body to glass seal, w/groove for chrome	100.00 ea
------------	---	-----------

### Antennas

11A-18813-A	1941 Convertible & Wagon, Windshield Mount	165.00 ea
21A-18813-A	1942-48 Convertible, Windshield mount	165.00 ea
6A-18813	1946-47 Passenger, cowl mount	105.00 ea

### Antenna Hole Plugs

*Go on inside of windshield. Used only when no antenna is used.*

11A-7004385-A	1941 Passenger	7.50 ea
21A-7004385-A	1942 Passenger, maroon	7.50 ea
21A-7004385-B	1942 Passenger, butterscotch	7.50 ea
51A-7004385-A	1946 Passenger, chocolate	7.50 ea
51A-7004385-B	1946 Passenger, blue-grey	7.50 ea
51A-7004385-C	1946-48 Pass, grayish tan	7.50 ea

### Traffic signal finder prism

A-18300	Any year	7.50 ea
---------	----------	---------

### Windshield Center Mirrors

1940-42

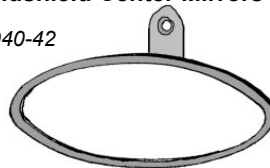

1942-48

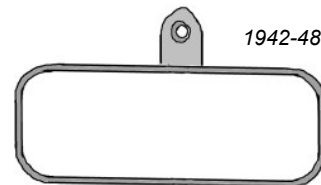

01A-17690	1940-42, Mirror w/stainless bracket	55.00 ea
6A-17690-SS	1942-48, Mirror w/stainless bracket	55.00 ea

### Cowl Mirrors

*Chrome Plated w/Stainless Head*

6A-18403-R	1942-48 RH Mirror	not.avbl
6A-18403-L	1942-48 LH Mirror	not.avbl
11A-18402-RP	1941 RH Base pad, rubber	12.50 ea
11A-18403-RP	1941 LH Base pad, rubber	12.50 ea
21A-18402-RP	1942-46RH Base pad, rubber	12.50 ea
21A-18403-RP	1942-48LH Base pad, rubber	12.50 ea

### Convertible Top Header to Windshield Seal

11A-763200	Upper, mounts to header	10.00 ea
11A-763200-T	Lower, mounts to windshield	10.00 ea

### 1941-48 Top Wood (Ford or Mercury)

21A-764855-1	1941 Convertible header	800.00 ea
11A-764855-3	1941 Convertible rear bow	400.00 ea
21A-764855-1	1942-48 Convertible header	800.00 ea
21A-764855-3	1942-48 Convertible rear bow	375.00 ea

\* Parts with price listed as "not.avbl" are not known to be available at this time, but are listed for reference.

## 1941-48 Ford and Mercury Convertible & Station Wagon Windshield and Top, cont

### Top Latch Catches and Dowels on Windshield

Catches are cast Bronze, drilled and machined, Plated or unplated.

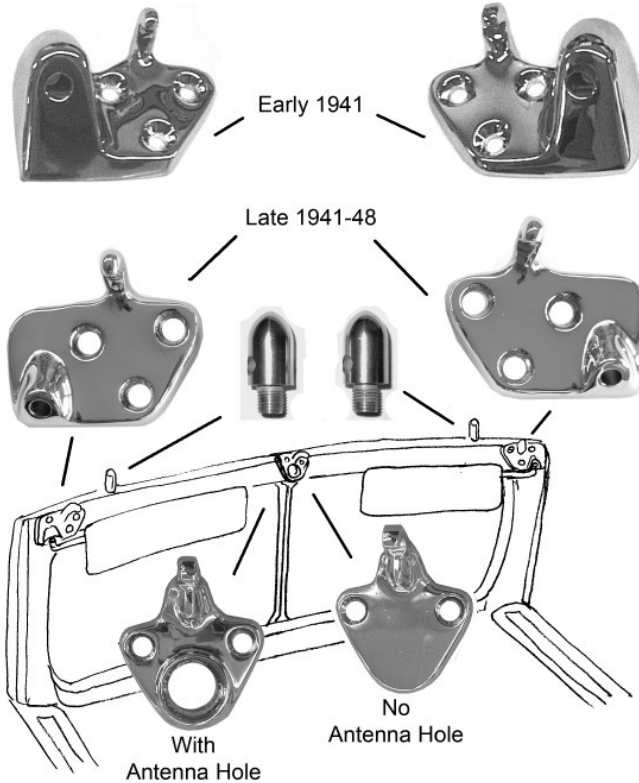

### Alignment Dowel on Windshield

11A-7603442-S Stainless 100.00 pr

### Center Catch

11A-7603458-H Center catch no center hole, plain 100.00 ea

11A-7603458-HC Center catch, no center hole, chrome 150.00 ea

11A-7603458-S Center catch w/antenna hole, plain 100.00 ea

11A-7603458-SC Center catch w/antenna hole, chrome 150.00 ea

### Early 1941 Side Catch/Visor Bracket

11A-7604144-AS Side catch/visor bracket, plain 250.00 pr

11A-7604144-ASC Side catch/visor bracket, chrome 350.00 pr

91A-7604414 Sun Visor Ams only, chrome not.avbl

01A-7604144-SPG Springs for visor arm 5.00 ea

### Late 1941-48 Side Catch/Visor Bracket

11A-7604144-S Side catch/visor bracket, plain 150.00 pr

11A-7604144-SC Side catch/visor bracket, chrome 250.00 pr

11A-7604414-ARM Sun Visor Ams only, chrome not.avbl

11A-7604144-SPR Springs for visor arm 5.00 ea

### 1941-48 Top Latches

Mount to top header. Cast Bronze, drilled and machined, Available plated and assembled or as unassembled unplated kits.



11A-7603520-S	Top side latch kit, plain	175.00 ea
11A-7603520-SC	Top side latch assy, chrome	225.00 ea
11A-7603522-S	Top center latch kit, plain	175.00 ea
11A-7603522-SC	Top center latch assy, chrome	250.00 ea

### Individual components available separately:

11A-7603522-2	Center latch base, unplated	35.00 ea
11A-7603522-3	Center mount plate, unplated	35.00 ea
11A-7603520-1	Lever only, unplated	37.50 ea

### Back Window Frames

(glass not included)

Stainless outer,  
tan inner

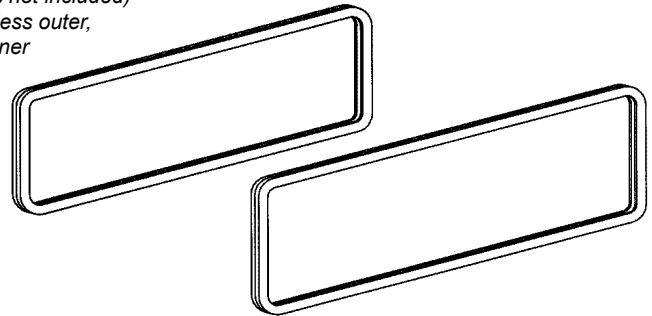

11A-7653220-PL	1941-48 (22 7/8" x 8" od)	325.00 ea
8A-7653220-PL	1949-50 (26" x 9" od)	375.00 ea

### Top and Windshield Post to Door Window Frame Seals

1940-48 Top to window seals are 3/4" wide.

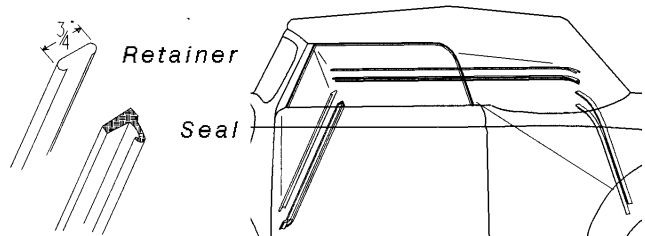

01A-7651562	Seal, window to top, 30"length, rubber	5.00 ea
01A-7651562-F	Seal, window to top, 30"length, w/felt flocking	7.50 ea
01A-7651560-S	Retainer, stainless steel, 30"length	32.50 ea
18-45983-F	Felted flocking, self adhesive, 10 foot	20.00 ea

### Top Iron Rest Pads in Top Well

11A-7631248/9	1941 Convertible	not.avbl
---------------	------------------	----------

\* Parts with price listed as "not.avbl" are not known to be available at this time, but are listed for reference.

## Windshield Wipers

### Hand Wiper,

Chrome, with blade

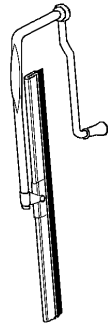

A-17655-AR Any year 25.00 ea

### Wiper Motor: 12 Volt Miniature Replacement

This is the smallest 12v wiper available. This wiper will fit inside header! 100 degree wipe, self park feature. Motor supplied with plastic cover.

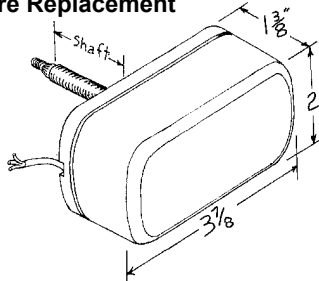

Uses 1937-40 style tapered shaft. Shaft nut included.

#### Motor:

B-17508-A10	1" shaft, 1932-36 Roadster & Phaeton 1926-29 Coupe, Tudor & Pickup	160.00 ea
B-17508-A15	1 1/2" shaft: 1928-31 Roadster & Phaeton 1935-38 Coupes & Sedans, 1935-47 Pickups	160.00 ea
B-17508-A20	2" shaft: 1930-31 Victoria & Slant Windshield 1932-34 Coupes & Sedans, 1938-47 Cabover	160.00 ea
B-17508-A25	2 1/2" shaft: 1930-31 Coupe, Sedan, Pickup (requires hollowing of wood header above windshield)	160.00 ea

### Finned Aluminum Cover for Miniature Motor

Cast aluminum, includes mounting screws, Replaces the plastic cover on the Pacific Western Design mini wiper. Perfect for roadsters and phaetons where the motor is exposed



B-17508-C 125.00 ea

### 12 Volt Universal Replacement Wiper Kits

Motor has stainless steel housing, 110 degree wipe and automatic return. An adjustable (8"-12") wiper arm and an 11" blade are included. The wiper shaft can easily be shortened. This wiper will extend past header area. Has a plain 1/4" shaft.

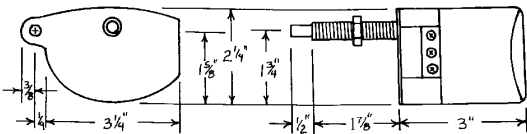

A-17085-SS	12v Universal wiper kit	50.00 ea
SR-17508-SWK	12v Universal wiper w/quick release kit	140.00 ea
U-17529	Arm for universal A-17085-SS motor	17.50 ea
U-17529-CHP	Chopped arm, 6" to 8", for A-17085-SS motor	17.50 ea
U-17528	Blade for universal A-17085-SS motor	5.00 ea

### Replacement Electric Wiper Motor for 1928-36 Arms

Similar dimensions to universal wiper except with switch at back. Arms and blades not included

A-17085-12	12 volt	40.00 ea
A-17085-6	6 volt	45.00 ea

### Roadster "quick release" wiper system

Designed to clamp to the top of the windshield frame for use only when needed. Includes motor, blades, clamps and wire.

SR-17508-SWK 1926-36 140.00 ea

### Specialty Power Windows Wiper Kit

This is the heaviest duty unit available. Universal dual wiper drive has two wiper shafts with a simple to adjust 90 to 160 degree sweep. Towers accept either 1/2" fine knurl end arms (1941-modern), or 1/4" round shaft arm ends. Power is by a high torque late model design wiper motor, using a push-pull cable transmission. For above windshield mounted wipers cable routing is difficult through windshield post so mounting motor behind doors is recommended.

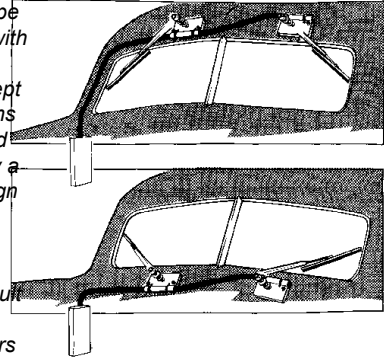

SPW-WWK2I	Wiper Kit for cowl mounting	400.00 ea
SPW-WWKXLWD-2I	Wiper Kit w/long cable for trunk mounting	425.00 ea

### In Header 12v Wiper Kit

Mounts in header, includes transmission, wiper towers, wiper arms and blades

T-17508-2S	1926-27 Coupe & Sedan	450.00 ea
A-17508-A2S	1928-29 Coupe & Sedan	450.00 ea
A-17508-T2S	1928-29 Pickup	450.00 ea
A-17508-2S	1930-31 Coupe & Tudor	425.00 ea
B-17508-T2S	1932-34 Pickup	450.00 ea
48-17508-2S	1935-36 Coupe & Sedan	450.00 ea
50-17508-2S	1935-36 Pickup	450.00 ea
78-17508-C2S	1937 Coupe & Sedan	450.00 ea
81A-17508-C2S	1938 Coupe & Sedan	450.00 ea
01C-17508-2S	1940-47 Pickup	450.00 ea

### Direct Replacement 12 volt Wiper Motors

Replaces original vacuum wiper and uses original transmission and towers.

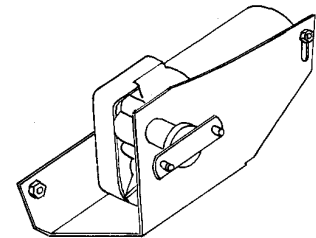

78-17508-2S	1937-39 Convertible & Wagon (stock under dash location)	250.00 ea
91A-17508-2S	1939 Coupe & Sedan	250.00 ea
01A-17508-2S	1940 Passenger (firewall mount)	250.00 ea
11A-17508-2S	1941 Coupe, Sedan & Convertible	250.00 ea
21A-17508-2S	1942-47 Coupe, Sedan & Convertible	250.00 ea
6A-17508-2S	1948 Coupe, Sedan & Convertible	250.00 ea
7C-17508-2S	1948-50 Pickup	250.00 ea
1C-17508-2S	1951-52 Pickup (replaces vacuum motor)	250.00 ea
1C-17508-E2S	1951-52 Pickup (replaces original electric motor)	275.00 ea
BAAA-17508-2S	1953-55 Pickup (replaces vacuum motor)	250.00 ea
BAAA-17508-E2S	1953-55 Pickup (replaces original electric motor)	275.00 ea
B6C-17508-2S	1956-60 Pickup (replaces vacuum motor)	250.00 ea
B6C-17508-E2S	1956-60 Pickup (replaces original electric motor)	275.00 ea

### Wiper Motor to Linkage Spring Clip

78-17540	1937-40 Convertible/Wagon, 1940 Passenger	5.00 ea
06H-17531	1941-48 Passenger, 1948-56 Pickup	2.00 ea

\* Parts with price listed as "not.avbl" are not known to be available at this time, but are listed for reference.

## Windshield Wipers, cont

### Wiper Tube (or Wiring) to Cowl Grommet

B-17523	1932-36 Roadster & Phaeton	7.50 ea
---------	----------------------------	---------

### Wiper motor to windshield frame clamp

1926-31 Roadster & Phaeton

A-17589-S	fits original vacuum motor use spacers with mini wiper	10.00 set
-----------	---	-----------

### Wiper Motor Shaft to Roof Seals & Bezels

40-17515	1933-34 Coupe & Sedan: Bezel, chrome	not.avbl
40-17541	1933-34 Coupe & Sedan: Seal, rubber	3.00 ea
48-17515	1935-36 Coupe, Sedan & PU: Bezel, chrome	not.avbl
48-17541	1935-36 Coupe, Sedan & PU: Seal, rubber	5.00 ea
78-17515	1937-39 Coupe, Sedan & PU: Bezel, chrome	12.50 ea
11A-17541	1937-39 Coupe, Sedan & PU: Seals, rubber	3.00 pr

### Wiper Motor Shaft to Cowl Seals and Bezels

01C-17515	1940-47 Pickup: Bezel, chrome	not.avbl
11A-17541	1940-47 Pickup: Seal, rubber	3.00 pr
11A-17515	1941-48 Passenger: Bezel, chrome	22.50 pr
11A-17541	1941-48 Passenger: Seal	3.00 pr
7C-17515	1948-52 PU: Bezel, chrome, RH or LH	10.00 ea
7C-17515-NUT	1948-52 PU : Nut (hex), chrome, RH or LH	7.50 ea
7C-17541	1948-52 PU: Seal, 1948-52	3.00 pr
BAAA-17515	1953-56 PU: Bezel, chrome, RH or LH	7.50 ea
7C-17515-NUT	1953-55 PU: Nut (hex), chrome, RH or LH	7.50 ea
B6C-17515-NUT	1956 PU: Nut (slotted), chrome, RH or LH	7.50 ea
BAAA-17541	1953-56 PU: Seal, 1953-56	3.00 pr

### Windshield Wiper Towers on Body

Includes both towers and linkage to motor

1940 Convertible/Wagon towers and linkage can be used on 1937-39 Convertible/Wagon by using a 1940 style firewall mount motor.

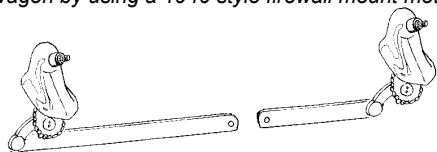

78-17552-S	Wiper Towers: 1937-39 Convertible/Wagon	120.00 set
01A-17552-CS	Wiper Towers: 1940 Convertible/Wagon	175.00 set
01A-17552-DS	Wiper Towers: 1940 Coupe & Sedan	120.00 set
78-17556	Pads: 1937-40 Convertible	5.00 pr
01A-17556	Pads: 1940 Coupe & Sedan	5.00 pr

### 1948-56 Pickup Wiper Pivot

7C-17566-A	RH, 1951-52 Pickup	35.00 ea
7C-17567-A	LH, 1951-52 Pickup	35.00 ea
BAAA-17566	RH or LH, 1953-55 Pickup	30.00 ea
B6C-17566	RH or LH, 1956 Pickup	30.00 ea

### Wiper Arms and Blade for 1928-36 Wiper Shaft

Fits the 1928-36 shaft with the groove and pin hole.

Note that most cars and pickup with visor used an external mount wiper motor.

#### Wiper Arms

A-17529	for external mount vacuum motor	5.00 ea
B-17529	for internal mounted motors	10.00 ea

#### Wiper Blade

A-17528	Wiper blade, 7 1/4"	5.00 ea
68-17528	Wiper blade, 8 1/4"	5.00 ea
11A-17528	Wiper blade, 9"	5.00 ea



### Wiper Arms and Blades for 1937-40 Taper shaft

1937-40 Style arms and blades fit original vacuum wipers or 12v miniature replacement motors.

Original Ford used the hook style. Hook style blades can be easily shortened. Hook style arms can be shortened with modest effort.

Wrist style arms and blades are the 1950's style attachment and are not easily shortened.

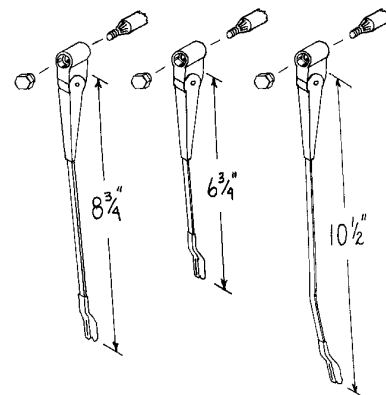

"Hook Style"		"Wrist Style"		
Wiper Arm 6 3/4"	01A-17529	17.50 ea	01A-17529-WT	17.50 ea
Wiper Arm, 8 3/4"	78-17529	17.50 ea	78-17529-WT	17.50 ea
Wiper Arm, 10 1/2" LH	01C-17526-LH	17.50 ea	01C-17527-WT	17.50 ea
Wiper Arm, 10 1/2" RH	01C-17526-RH	17.50 ea	01C-17526-WT	17.50 ea
Wiper Blade, 6"	A-17528	5.00 ea	SR-17528	15.00 ea
Wiper Blade, 8"	68-17528	5.00 ea	78-17528-WT	15.00 ea
Wiper Blade, 9"	11A-17528	5.00 ea		
Wiper Arm Shaft Nut	78-17481	7.50 ea		

### 1/2 Spline Shaft Adaptor

1/2" Spline shaft end to mount to 1928-36 groove & pin style, 1/4" smooth, and 1937-40 taper shaft (nut not included)

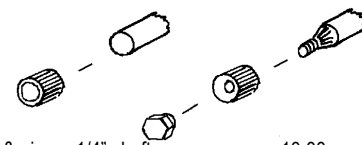

11A-17500-2836	fits 1928-36 groove & pin, or 1/4" shaft	10.00 ea
11A-17500-3740	fits 1937-40 taper shaft	10.00 ea

### Wiper Arms and Blades Fit 1941-Modern 1/2" Spline shaft

"Hook" blade/arm connection style were original through 1948. Hook style blades can easily be shortened. Wrist style was typical 1949-1950's. A more effective wiper design yet difficult to modify length

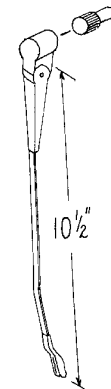

	Hook Style	Wrist Style.		
6" blade		SR-17528	15.00 ea	
7 1/2" blade	A-17528	5.00 ea		
8 1/4" blade	68-17528	5.00 ea	78-17528-WT	15.00 ea
9" blade (41-48)	11A-17528	5.00 ea		
10" blade (48-52 PU)			7C-17528	15.00 ea
11" blade			8A-17528	17.50 ea
12" blade (53-56 PU)			B6C-17528	15.00 ea
Arm RH 41-48 10 1/2"	11A-17529-R	17.50 ea	11A-17529-RW	17.50 ea
Arm LH 41-48 10 1/2"	11A-17529-L	17.50 ea	11A-17529-LW	17.50 ea
Arm, 48-52 PU	7C-17527	17.50 ea		15.00 ea
Arm, 53-55 PU	B6C-17527	17.50 ea		15.00 ea
Arm, 56 PU LH	B6C-17527	17.50 ea		15.00 ea
Arm, 56 PU RH	B6C-17526	17.50 ea		15.00 ea

\* Parts with price listed as "not.avbl" are not known to be available at this time, but are listed for reference.