

1935 Passenger Grille, Hood, Fenders & Running Boards



Grille Ornament

Ornament, Chromed

48-8215 110.00 ea

Ford Emblem

Chrome with blue background

40-8212-B 20.00 ea

Accessory Greyhound

Chrome, Mounts to ornament

48-8100-G not.avbl

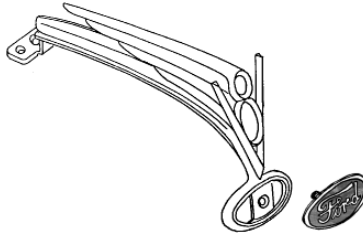

1935 Passenger Grille

Grille:

48-8200 not.avbl

Grille trim set with mount clips:

Stainless Steel

48-8234 135.00 ea

Grille trim mount clip set (34 pcs):

48-20001 10.00 set

Grille Bug Screen

48-18700 65.00 ea



Grille Inner Baffle

Fiberglass

GSP35P 175.00 ea



Hood Side Trim & Hardware

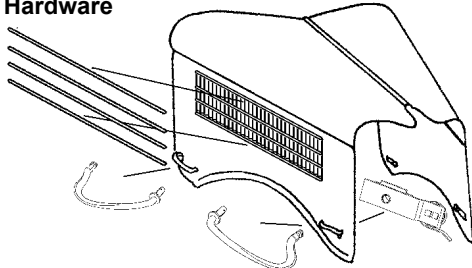

40-16636-BR	Handle, RH front, LH rear, bronze	15.00 ea
40-16636-BL	Handle, LH front, RH rear, bronze	15.00 ea
48-16644/5-B	Handles, set of 4, polished stainless	not.avbl
40-16637-BR	Bracket & Spring, RH front, LH rear	25.00 ea
40-16637-BL	Bracket & Spring, LH front, RH rear	25.00 ea
48-16722	Side trim, stainless, set of 8 with clips	155.00 set
48-20004	Side trim clip set (32 pcs)	10.00 set
48-16761	Hood rubber bumper kit, w/corner rubber	25.00 set

Stock and Street Rod Hoods

Steel Hoods by Rootlieb

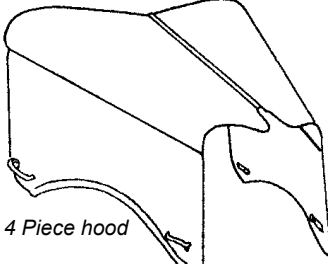

4 Piece hood

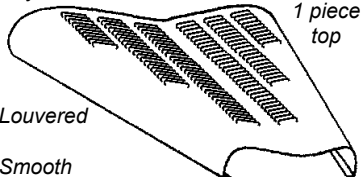

1 piece top

Stock Hood top includes center hinge. Side panels are complete with hood handles and hinge rods.

One piece top panel does not have cutout for ornament. 3 piece Side panels do not have handles. Hood hinges and top panel braces not included, sold separately.

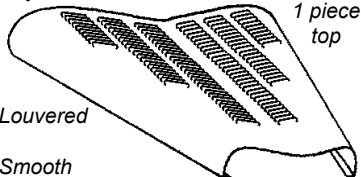

Louvered

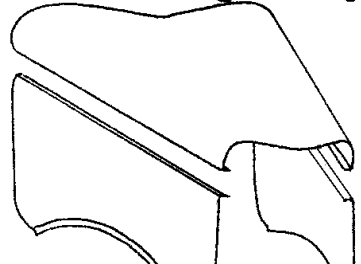

Smooth

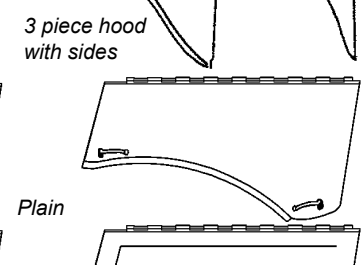

3 piece hood with sides

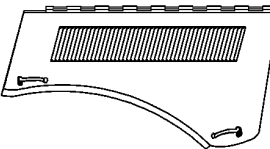

Stock

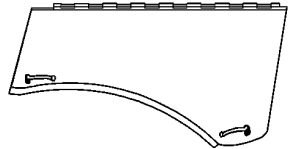

Plain

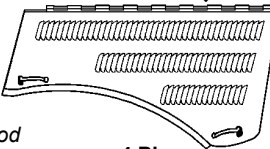

Hot Rod

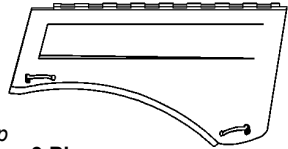

Scoop

	4 Piece		3 Piece	
Top, Smooth	48-16710	500.00 ea	48-16710-3	575.00 ea
Top, 6 rows louvers	48-16710-L	675.00 ea	48-16710-3L	725.00 ea
Sides, Stock louvers	48-16712	not.avbl	48-16713	not.avbl
Sides, Hot Rod Louvers	48-16712-H	325.00 pr	48-16713-H	325.00 pr
Sides, Plain	48-16712-P	325.00 pr	48-16713-P	325.00 pr
Sides, Scoop	48-16712-S	650.00 pr	48-16713-S	650.00 pr

Hood Lacing on Grille or Cowl

40-16739-S	Grille: 1933-35 Pass, fabric w/rivets	17.50 ea
48-16740-S	Cowl: 1935 Passenger, fabric, w/screws	20.00 ea
HR-16739	Foam rubber, 3/8" x 3/16" (most rad shells)	100.00 ea
HR-16740	Foam rubber, 5/8" x 3/8" (most cowls)	125.00 ea

Hinge and Braces for 3-Piece Hoods

Top Panel Braces

3/8" round steel braces provide extra support. This minimizes flexing and helps to avoid cracking paint and smooths operation of hidden hinges.

46-16714-DF Braces 90.00 set

Hidden hinge and latch kit:

By DF Metalworks. Includes hinges, latches, and side panel lower alignment pins. Hardware and instructions are included.

B-16711-DF	LH Open	375.00 set
B-16711-DF2	2 Way Open	475.00 set

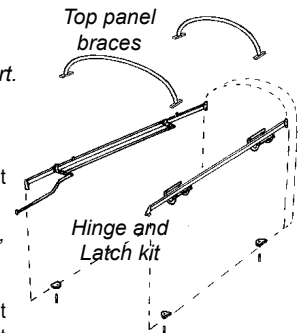

4 Piece Hood Hinge

Hinge Brackets (front or rear)

B-8220	Hinge brackets, stainless	15.00 ea
40-16632	Center hinge strip, stainless	30.00 ea
48-16631-S	Side panel rods, ss, 3/7 3/4"	17.50 pr
HR-16780-SS	Accessory hood support mounts to radiator rods	45.00 ea

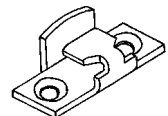

* Parts with price listed as "not.avbl" are not known to be available at this time, but are listed for reference.

1935 Passenger Grille, Hood, Fenders and Running Boards, cont

1935 Passenger Front Fenders, Fiberglass



RFF35P	RH Front fender	625.00 ea
LFF35P	LH Front fender	625.00 ea
RFI35P	RH inner fender	175.00 ea
LFI35P	LH inner fender	175.00 ea

Fender Brackets

Fender/headlight support:

48-16025-R	RH:	not.avbl
48-16025-L	LH:	not.avbl
Support bracket to frame strut:		
48-16067-R	RH:	10.00 ea
48-16067-L	LH:	10.00 ea

Skirt brace, RH or LH

48-16094		30.00 ea
----------	--	----------

Rear Fender brace

48-16391	RH or LH	27.50 ea
----------	----------	----------

Headlight Support

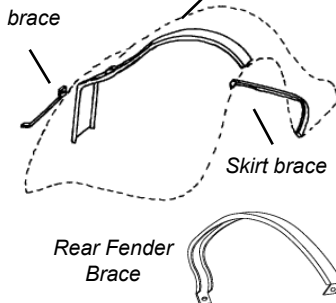

1935-36 Fender Washer Sets

Set of 28 washers, enough for both front and rear fenders.

48-16008-SK		10.00 ea
-------------	--	----------

5/16-24 Cage Nuts

Welded to body and frame for fender and running board mounting.

AH-3145	Cage nut	1.50 ea
---------	----------	---------

Fender Welt

Black vinyl, 25 ft. length

48-16070-B	3/16" bead	17.50 ea
48-16070-D	1/4" bead	17.50 ea

Vinyl, clad w/stainless bead, 8 ft.

48-16070-SS	7/32" bead	22.50 ea
-------------	------------	----------

Vinyl, COLORED, Use part suffix to indicate color

Maroon: -MR, Caramel: -CR, Medium Blue: -BLM, Red: -RD, Dark Brown: -BRD, Dark Green: -GRD, White: -WH, Grey: -GY, Bright Orange: -OR, Yellow: -YL, Bright Red: -RR

48-16070-xx	25 ft length, Specify Color	40.00 ea
-------------	-----------------------------	----------

1935 Coupe, Roadster, & Cabriolet

Rear Fenders

Fiberglass

Right:		
RRF35CR		475.00 ea

Left:		
LRF35CR		475.00 ea



1935 Sedan & Phaeton

Rear Fenders

Fiberglass

Right:		
RRF35SPH		475.00 ea

Left:		
LRF35SPH		475.00 ea



1935-36 Station Wagon & Sedan Delivery

Rear Fenders

Fiberglass

Note: Inner flange of fender needs to be trimmed to fit Sedan Delivery

Right:		
RRF3539SD		475.00 ea

Left:		
LRF3539SD		475.00 ea



Teardrop Fender Skirts, Fiberglass

Excellent fiberglass reproductions of the aftermarket bubbled fender skirts that were so popular in the '50's. Includes locking arms to latch to the top of the fender, clamps to the bottom of the skirts to the front and rear of the wheel opening, stainless screws, and rubber seals.

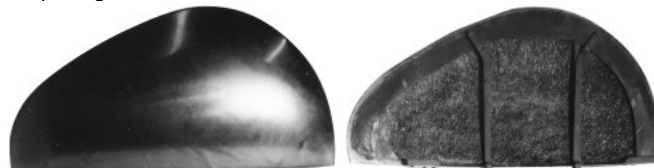

FST3536F	Fender Skirts, fiberglass	700.00 pr
----------	---------------------------	-----------

1935-36 Passenger Running Boards

Fiberglass, smoothie style

Fiberglass boards are very strong, over 1/4" thick. They have the proper arch for excellent fit and appearance



RRB3536PS	RH, smooth running board	450.00 ea
LRB3536PS	LH, smooth running board	450.00 ea

Steel boards and rubber covers:

Steel boards with vulcanized rubber covers are excellent quality.

48-16450/1-BD	Steel boards w/molded rubber cover	1175.00 pr
48-16450/1	Molded rubber replacement covers	225.00 pr
48-16455-MB	1935-48 Running board mount bolt	1.00 ea

1935-36 Passenger Running Board Moldings

48-16462-S	Stainless moldings	85.00 pr
------------	--------------------	----------

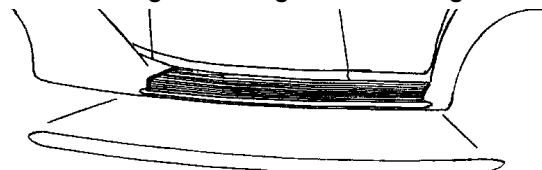

* Parts with price listed as "not.avbl" are not known to be available at this time, but are listed for reference.