

## 1926-27 Radiator Shell, Hood, Fenders and Running Boards

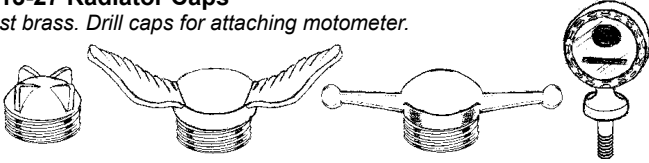

### 1913-27 Radiator Caps

Cast brass. Drill caps for attaching motometer.



|              | Polished Brass |          | Chromed    |          |
|--------------|----------------|----------|------------|----------|
| Stock cap    | T-3926-B       | 15.00 ea | T-3926-C   | 17.50 ea |
| Dogbone cap  | T-3926-DB      | not.avbl | T-3926-DC  | not.avbl |
| Gullwing cap | T-3926-GB      | 25.00 ea | T-3926-GC  | 27.50 ea |
| Motometer    | B-18354-BW     | 55.00 ea | B-18354-CW | 55.00 ea |

### Radiator Shells & Shields

#### Radiator Shell:

1917-23 "short" style: (includes shield)

|           |        |           |
|-----------|--------|-----------|
| T-8200-A  | Plain  | 180.00 ea |
| T-8200-AC | Chrome | 275.00 ea |

1924-25 "tall" style:

|          |       |          |
|----------|-------|----------|
| T-8200-B | Plain | not.avbl |
|----------|-------|----------|

1926-27 "tall" tapered style:

|           |       |          |
|-----------|-------|----------|
| T-8200-CP | Plain | not.avbl |
|-----------|-------|----------|

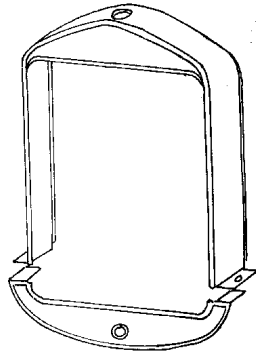

#### Lower shield & trim:

|           |                                       |          |
|-----------|---------------------------------------|----------|
| T-8201-A  | 1917-25, with crank hole, plain steel | 30.00 ea |
| T-8201-B  | 1926-27 with crank hole, plain steel  | 30.00 ea |
| T-8201-SR | 1926-27 no crank hole, plain steel    | 30.00 ea |
| T-3977-D  | 1926-27 lower trim, chrome            | 20.00 ea |

#### Radiator Shell Mount Bolt Set

|           |         |          |
|-----------|---------|----------|
| A-8201-AM | 1923-29 | 1.50 set |
|-----------|---------|----------|

### Chopped 4-1/2" 1932 Grille Shell

Ideal for 1926-27. Features a smooth lacing lip at back of shell.

#### 4-1/2" Chop Grille Shell

|         |                          |           |
|---------|--------------------------|-----------|
| GS32PF4 | Filled style, fiberglass | 325.00 ea |
|---------|--------------------------|-----------|

#### 4-1/2" Chop Grille insert

|           |                          |          |
|-----------|--------------------------|----------|
| B-8200-IE | Stainless, No crank hole | not.avbl |
|-----------|--------------------------|----------|

#### 4-1/2" Front Splash Apron

|           |   |           |
|-----------|---|-----------|
| FSA27T2AF | Fits 1926-27 cars using 1928-29 fenders and 4 1/2" chop 1932 grille shell. Fiberglass | 200.00 ea |
|-----------|---|-----------|



### 1926-27 Stock and Street Rod Hoods

Steel hoods by Rootlieb.

4 Piece Hood

1 piece top

or 3 piece with sides

Hood top includes center hinge. (We recommend the V8 hinge on street rods for ease of opening and to help prevent paint chipping). Side panels are complete with hood handles and hinge rods.

Hood top can be used a top panel only. Side panels do not have handles.

Hood hinges and top panel braces not included, sold separately.

### Hood Tops

Stock hinge

V8 Style hinge

One Piece

Louvered

|                      | 4 piece     |           | 3 piece (*no hinge) |           |
|----------------------|-------------|-----------|---------------------|-----------|
| Plain (stock hinge*) | T-16710-E   | 200.00 ea | T-16710-E3          | 220.00 ea |
| Plain (V8 hinge*)    | T-16710-E2  | 225.00 ea |                     |           |
| Louvered (V8 hinge*) | T-16710-E2L | 350.00 ea | T-16710-E3L         | 350.00 ea |

### Hood Sides

Stock

Hot Rod

3 - Door

Plain

Single Scoop

Double Scoop

|                     | 4 Piece     |           | 3 Piece     |           |
|---------------------|-------------|-----------|-------------|-----------|
| Sides, stock        | T-16712-E   | 200.00 pr | T-16713-E   | 165.00 pr |
| Sides, hot rod      | T-16712-EH  | 200.00 pr | T-16713-EH  | 165.00 pr |
| Sides, plain        | T-16712-EP  | 200.00 pr | T-16713-EP  | 165.00 pr |
| Sides, single scoop | T-16712-ES1 | 525.00 pr | T-16713-ES1 | 500.00 pr |
| Sides, double scoop | T-16712-ES2 | 850.00 pr | T-16713-ES2 | 825.00 pr |
| Sides, 3-door       | T-16712-ED  | 600.00 pr |             |           |

### Hinge and Braces for 3-Piece Hoods

#### Top Panel Braces

3/8" round steel braces provide extra support. This minimizes flexing and helps to avoid cracking paint and smooths operation of hidden hinges.

|             |        |           |
|-------------|--------|-----------|
| T-16714-EDF | Braces | 90.00 set |
|-------------|--------|-----------|

#### Hidden hinge and latch kit:

By DF Metalworks. Includes hinges, latches, and side panel lower alignment pins. Hardware and instructions are included.

|             |            |            |
|-------------|------------|------------|
| A-16711-DF  | LH Open    | 375.00 set |
| A-16711-DF2 | 2 Way Open | 475.00 set |

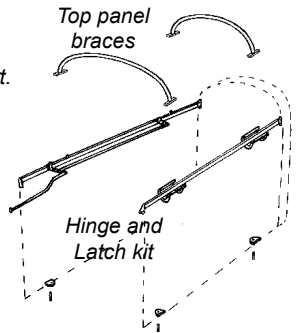

### Center Hinge Hinge Brackets

#### Stock type: front or rear:

|        |                                |        |         |
|--------|--------------------------------|--------|---------|
| A-8220 | For stock type round hinge rod | Chrome | 5.00 ea |
|--------|--------------------------------|--------|---------|

#### V8 Type: front or rear

|        |                                  |        |          |
|--------|----------------------------------|--------|----------|
| B-8220 | For reproduction hood w/V8 hinge | Chrome | 15.00 ea |
|--------|----------------------------------|--------|----------|

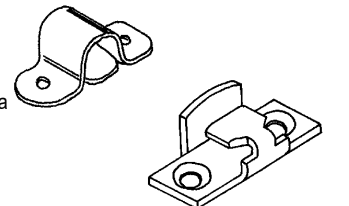

\* Parts with price listed as "not.avbl" are not known to be available at this time, but are listed for reference.

## 1926-27 Radiator Shell, Hood, Fenders and Running Boards

### Hood Latches and Hood Shelves

Top latches are original type, cast brass.  
Hood shelves fill space between hood and fenders.

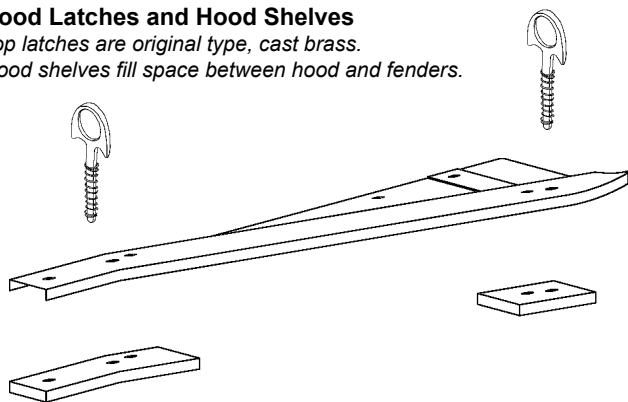

|            |   |       |     |
|------------|---|-------|-----|
| T-16750-BS | Hood Latches, Stock type, set of 4, brass w/springs | 30.00 | set |
| T-16713-S  | Hood shelves (fender/hood spacers), stamped steel   | 45.00 | pr  |
| T-16715-DS | Hood shelf wood block set, 4 pcs                    | 27.50 | set |

### Hood Lacing

We recommend fabric or hard rubber lacing for 4 piece hoods, foam rubber should only be used with 3 piece hoods.

|           |   |        |    |
|-----------|---|--------|----|
| T-16739-S | Radiator shell: Fabric original lace type   | 7.50   | ea |
| T-16740-S | Cowl: Fabric, w/rivets                      | 10.00  | ea |
| HR-16739  | Foam rubber, 3/8" x 3/16" (most rad shells) | 100.00 | ea |
| HR-16740  | Foam rubber, 5/8" x 3/8" (most cowls)       | 125.00 | ea |

### 1926-27 Front Fenders, Fiberglass



|          |          |        |    |
|----------|----------|--------|----|
| RFF2627A | RH Front | 450.00 | ea |
| LFF2627A | LH Front | 450.00 | ea |

### 1926-27 Rear Fenders, Fiberglass



|           |                              |        |    |
|-----------|------------------------------|--------|----|
| RFF2627CR | RH Rear: Coupe, Roadster, PU | 325.00 | ea |
| LRF2627CR | LH Rear: Coupe, Roadster, PU | 325.00 | ea |
| RRF2627ST | RH Rear: Sedan & Touring     | 325.00 | ea |
| LRF2627ST | LH Rear: Sedan & Touring     | 325.00 | ea |

### 1926-27 Fender Brackets

Front: Fits All Models

T-16025 60.00 ea

Rear: Coupe, Roadster, PU:

T-16180 50.00 ea

Rear: Sedan and Touring:

T-16391-ST not.avbl

Bracket to Fender Bolts

Stainless Steel, 1/2" long

B-16026-S2 2.50 pr

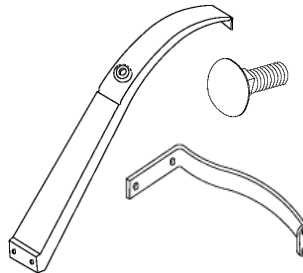

### Fender Welt

Black vinyl, 25 ft. length

48-16070-B 3/16" bead 17.50 ea

48-16070-D 1/4" bead 17.50 ea

Vinyl, clad w/stainless bead, 8 ft. length

48-16070-SS 7/32" bead 22.50 ea

Vinyl, COLORED, Use part suffix to indicate color

Maroon: -MR, Caramel: -CR, Medium Blue: -BLM, Red: -RD, Dark Brown: -BRD, Dark Green: -GRD, White: -WH, Grey: -GY, Bright Orange: -OR, Yellow: -YL, Bright Red: -RR

48-16070-xx 25 ft length, Specify Color 40.00 ea

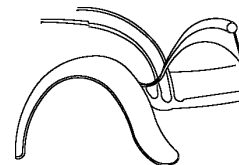

### 1926-27 Running Boards,

Stock style w/ diamond tread

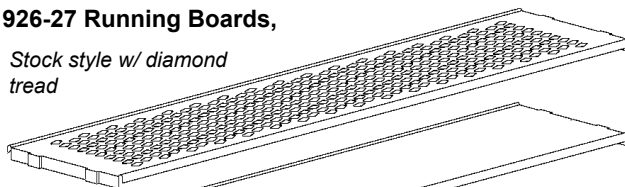

Smooth style



|            |  |        |     |
|------------|--|--------|-----|
| T-16450-S  | Running boards, stock style, stamped steel | 185.00 | pr  |
| T-16450-SM | Running boards, smooth style               | 175.00 | pr  |
| T-16455-MS | Mounting bolt set                          | 5.00   | set |
| T-16455-MW | Running board to bracket spacers, wood     | 15.00  | set |

### 1926-27 Running Board Splash Aprons

Stamped Steel

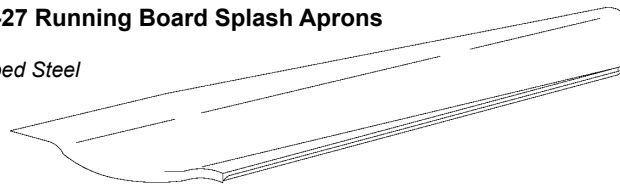

|            |          |        |    |
|------------|----------|--------|----|
| T-16532-S  | Plain    | 250.00 | pr |
| T-16532-LS | Louvered | 350.00 | pr |

### Custom Rear Rolled Pan Fiberglass



|           |                        |        |    |
|-----------|------------------------|--------|----|
| RRP2627R6 | 6" deep, Roadster only | 225.00 | ea |
|-----------|------------------------|--------|----|

### Special 1928-29 Style Rear Fenders for 1926-27 on "A" Frame

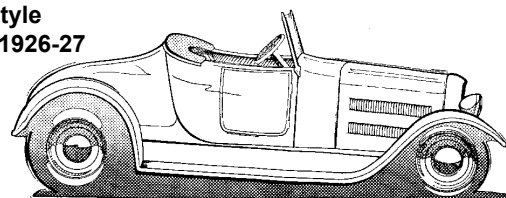

Special 1928-29 style rear fenders for 1926-27 Coupe or Roadster when using a 103 1/2" wheelbase Model A chassis. Use 1928 or 1929 Front fenders. Special length Model A style running boards and splash aprons must be used. Note a custom length hood must be used. Our 4 1/2" chop 1932 grille shell and custom front apron are a perfect match for these fenders.

|              |  |        |    |
|--------------|--|--------|----|
| RRF2627CRA   | RH fender: Coupe, Roadster, PU, glas   | 325.00 | ea |
| LRF2627CRA   | LH fender: Coupe, Roadster, PU, glas   | 325.00 | ea |
| A-16450-26SM | Running Boards, steel (x-long '28)     | 250.00 | pr |
| A-16532-26S  | Side splash aprons, steel (x-long '28) | 225.00 | pr |



\* Parts with price listed as "not.avbl" are not known to be available at this time, but are listed for reference.